

ST98

汽车继电器 Automotive Relays

- 80A触点切换能力80A rating switching capability
- 可提供塑料支架和金属支架 Plastic Bracket & Metal Bracket Available
- 环境温度Ambient temperature range: -40°C~ 125°C
- 外形尺寸 Outline dimensions: (26.0 x 26.0 x 23.7)mm



用途举例 Application Examples

RoHS

- 后窗除雾器 Rear Windows Defogger、
- 电池断路装置 Battery Disconnection Device、
- 汽车空调 Air-Conditioning System、
- 雾灯/大灯控制 Fog Lamp & Headlight Control、
- 油泵控制 Fuel Pump Control、
- 防抱死制动 ABS Control system 、
- 冷却风扇控制Cooling Fan Control、
- 电源管理系统 Power Management

型号命名标准 Product Code Structure

ST98	-12	R	T	-C	80	F	-S	-(XXX)
基本型号 Type								
ST98: 标准形式								
ST98P: PCB								
ST98M: Metal Bracket								
ST98B: Plastic Bracket								
线圈额定电压 Coil voltage								
12, 24								
线圈并联元件 Coil Paralleled Component								
Blank: Standard								
R: with resistor (680Ω 12V) (2700Ω 24V)								
D1: with diode (the diode anode on #85 terminal)								
D2: with diode (the diode anode on #86 terminal)								
耐热等级 Heat Resistant								
Blank: Standard type T: Heat resistant type								
触点结构 Contact form								
A -- FORM 1A, C -- FORM 1C								
触点负载 Contact Rating								
80: 80A								
触点材质 Contact material								
Blank-- AgSnO ₂ , F-- AgNi								
封装形式 Category of protection								

线圈参数 Coil Data(DC)

额定电压 Rated voltage (V)	线圈电阻 Coil resistance (Ω)	吸合电压 Operate voltage	释放电压 Release voltage	最大允许电压 Max release voltage	额定功耗 Rated coil power
		吸合电压的 % of rated voltage			
12	90	65% Max	10% Min	130%	Approx. 1.6W
24	320				Approx. 1.8W

触点参数 Contact Data

触点结构 Contact Arrangement	1A	1C
额定负载 Contact Rating	80A 14VDC	NO: 80A 14VDC NC: 60A 14VDC
接触电阻 Contact resistance	100mΩ max (1A/6VDC)	
最大开闭电流 Max. switching current	80A	
最大开闭功率 Max. continuous voltage	1120W	
最小开闭负载 Min. contact load	1A 6VDC	
机械寿命 Mechanical endurance,	1x10 ⁵ ops	
电气寿命 Electrical endurance	1x10 ⁵ ops	

性能参数 Characteristics

吸合时间 Operate time	≤15ms	
释放时间 Release time	≤15ms	
绝缘电阻 Insulation resistance	1000MΩ以上 (500VDC)	
介质耐压 Initial dielectric strength	线圈触点间 Between contact and coil	500V 50/60Hz 1min
	开路触点间 Between open contacts	500V 50/60Hz 1min
振动 Vibration resistance	10~500Hz, 5.0G	
冲击 Shock resistance	稳定性 Functional	10G
	强度 Destructive	100G
温度范围 Ambient operating temperature	Standard type	-40℃~+85℃ (no freezing)
	Heat resistant type	-40~125℃(no freezing)
湿度范围 Ambient operating humidity	5-85%RH	
重量 Weight	Approx.38g	

性能曲线 Engineering Data

Allowable ambient temperature

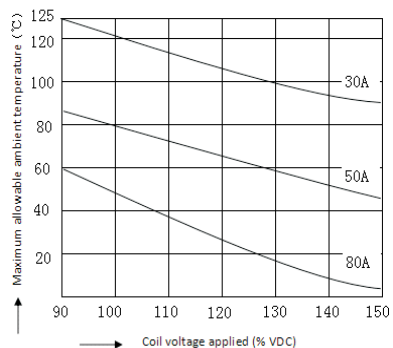

Ambient temperature and coil voltage (reference value of coil voltage 12VDC)

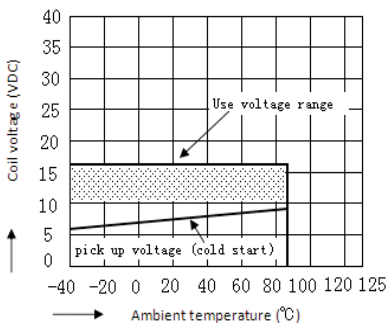

Coil temperature rise (ambient temperature 23 °C)

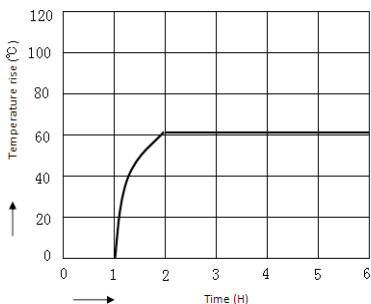

外形图、接线图、安装孔尺寸 Outline dimensions、PCB Layout、Wiring Diagram (mm)

外形图 Outline dimensions

安装孔 (底部视图) PCB Layout (Bottom View)

1) ST98

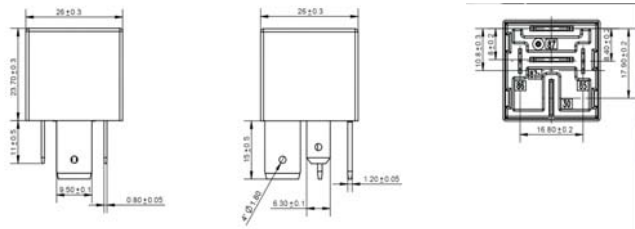

2) ST98P

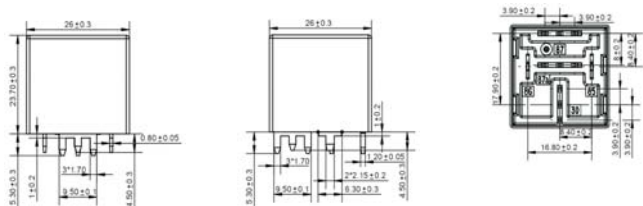

外形图、接线图、安装孔尺寸 Outline dimensions、PCB Layout、Wiring Diagram (mm)

外形图 Outline dimensions

安装孔 (底部视图) PCB Layout (Bottom View)

3) ST98M

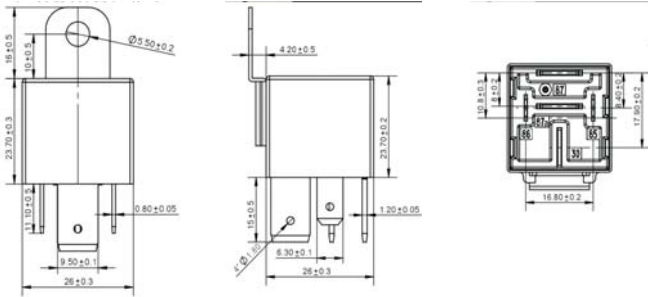

4) ST98B

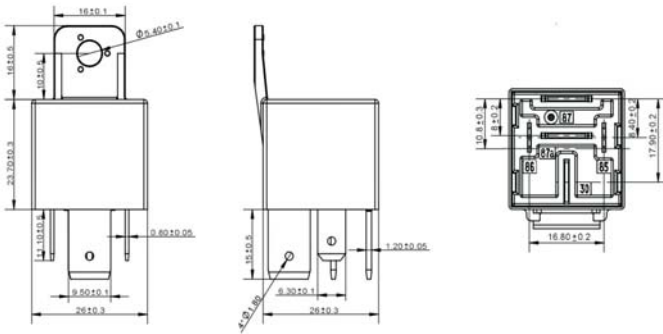

接线图 Wiring Diagram

